



NTSC U/C

PlayStation®



SLUS-00831
#21181

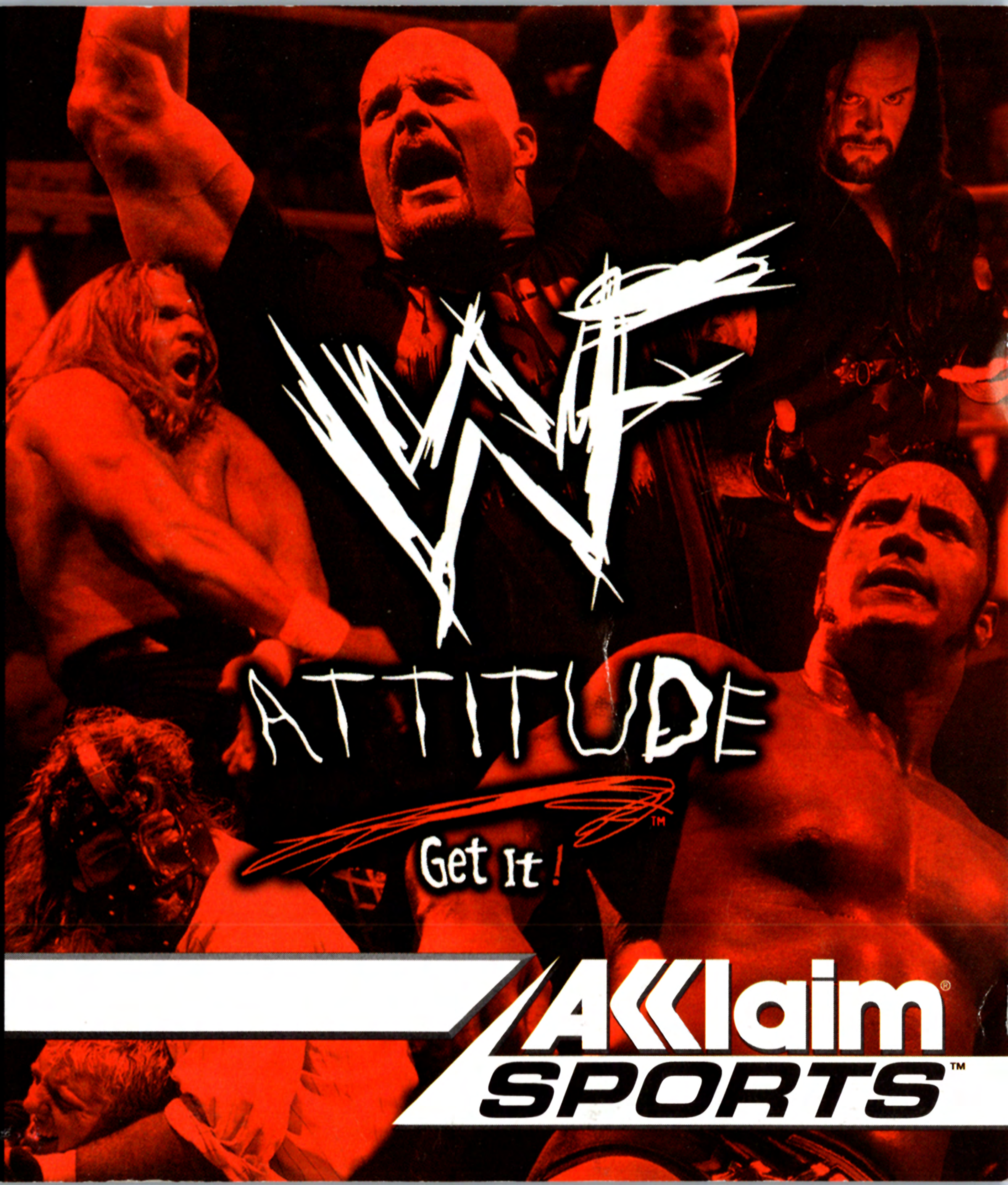

WRESTLING
ATTITUDE

Get It!

AKKlaim®
SPORTS™

WARNING: READ BEFORE USING YOUR PLAYSTATION® GAME CONSOLE.

A very small percentage of individuals may experience epileptic seizures when exposed to certain light patterns or flashing lights. Exposure to certain patterns or backgrounds on a television screen or while playing video games, including games played on the PlayStation game console, may induce an epileptic seizure in these individuals. Certain conditions may induce previously undetected epileptic symptoms even in persons who have no history of prior seizures or epilepsy. If you, or anyone in your family, has an epileptic condition, consult your physician prior to playing. If you experience any of the following symptoms while playing a video game – dizziness, altered vision, eye or muscle twitches, loss of awareness, disorientation, any involuntary movement, or convulsions – IMMEDIATELY discontinue use and consult your physician before resuming play.

WARNING TO OWNERS OF PROJECTION TELEVISIONS:

Do not connect your PlayStation game console to a projection TV without first consulting the user manual for your projection TV, unless it is of the LCD type. Otherwise, it may permanently damage your TV screen.

USE OF UNOFFICIAL PRODUCT:

The use of unofficial products and peripherals may damage your PlayStation game console and invalidate your console warranty.

HANDLING YOUR PLAYSTATION DISC:

- This compact disc is intended for use only with the PlayStation game console.
- Do not bend it, crush it or submerge it in liquids.
- Do not leave it in direct sunlight or near a radiator or other source of heat.
- Be sure to take an occasional rest break during extended play.
- Keep this compact disc clean. Always hold the disc by the edges and keep it in its protective case when not in use. Clean the disc with a lint-free, soft, dry cloth, wiping in straight lines from center to outer edge. Never use solvents or abrasive cleaners.

Table of Contents

| | |
|---------------------------------|--------------|
| Loading | 2 |
| Menu Controls | 3 |
| Do you have ATTITUDE? | 4 |
| Options | 5 |
| Default Controls | 6 |
| Ring Basics | 6 |
| Game Modes | 8 |
| Career | 10 |
| Exhibition | 12 |
| King of the Ring™ | 16 |
| Pay-Per-View | 17 |
| Create a Wrestler | 19 |
| Attributes | 21 |
| Utilities | 22 |
| Superstars with Attitude | 24–25 |

In Memory of Owen Hart

The World Wrestling Federation and Acclaim Entertainment would like to dedicate  to the memory of Owen Hart. Owen loved the wrestling business and lived to entertain both in and out of the ring. He was a consummate performer and a very special human being. If the legacy of a man's life is measured by the lives he touched and how much he is loved...then a big piece of Owen Hart will live on in all of us.

Owen James Hart
May 7, 1965 - May 23, 1999

LOADING

1. Set up your PlayStation® game console according to the instructions in its instruction manual.
2. Make sure the power is OFF before inserting or removing a compact disc. Insert the  disc and close the disc cover. If you wish to save your game, insert a Memory Card (sold separately) into Memory Card Slot 1.

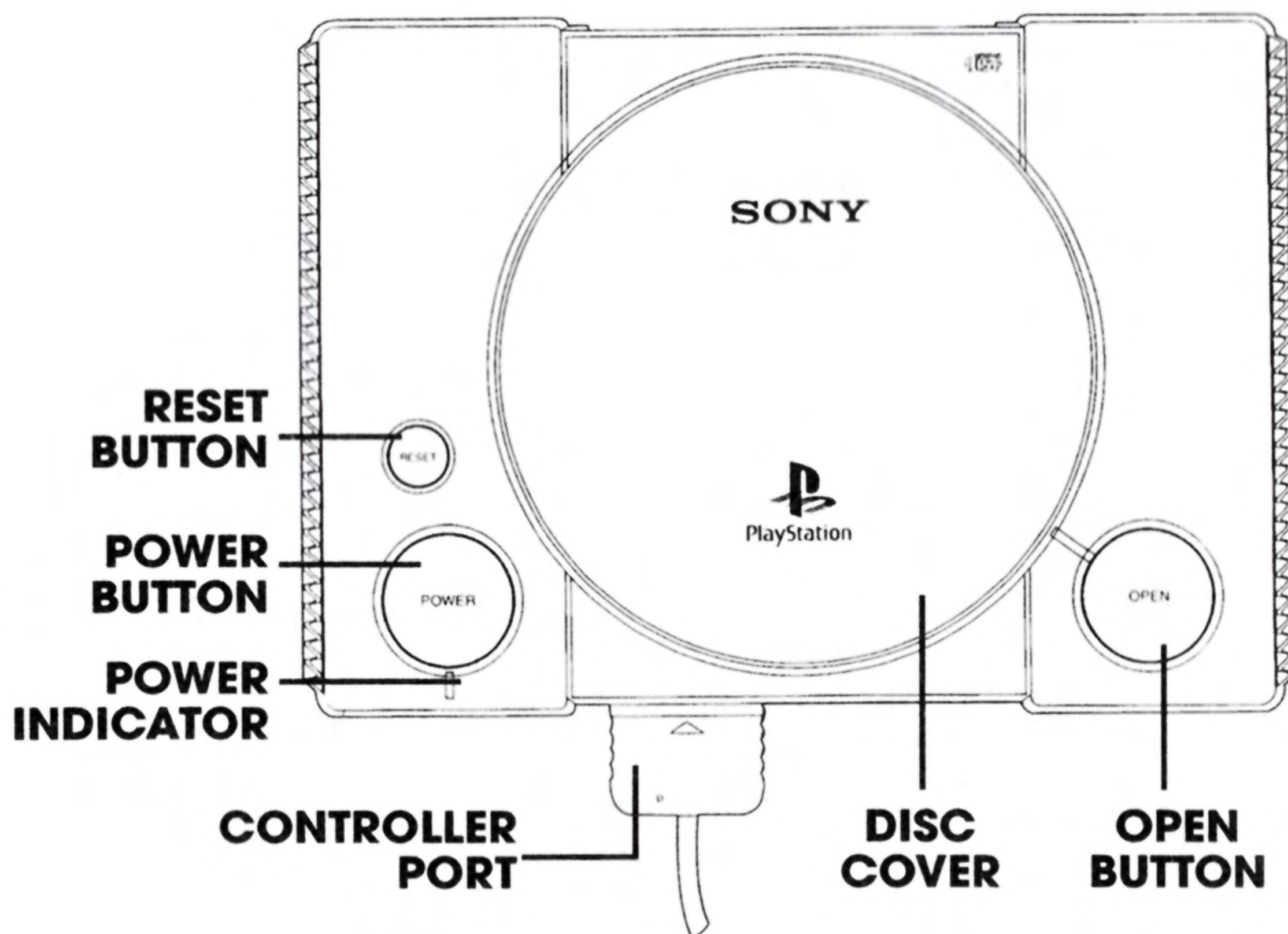

- 3. Insert game controllers and turn on the PlayStation® game console.
- 4. Follow on-screen instructions to start a game.

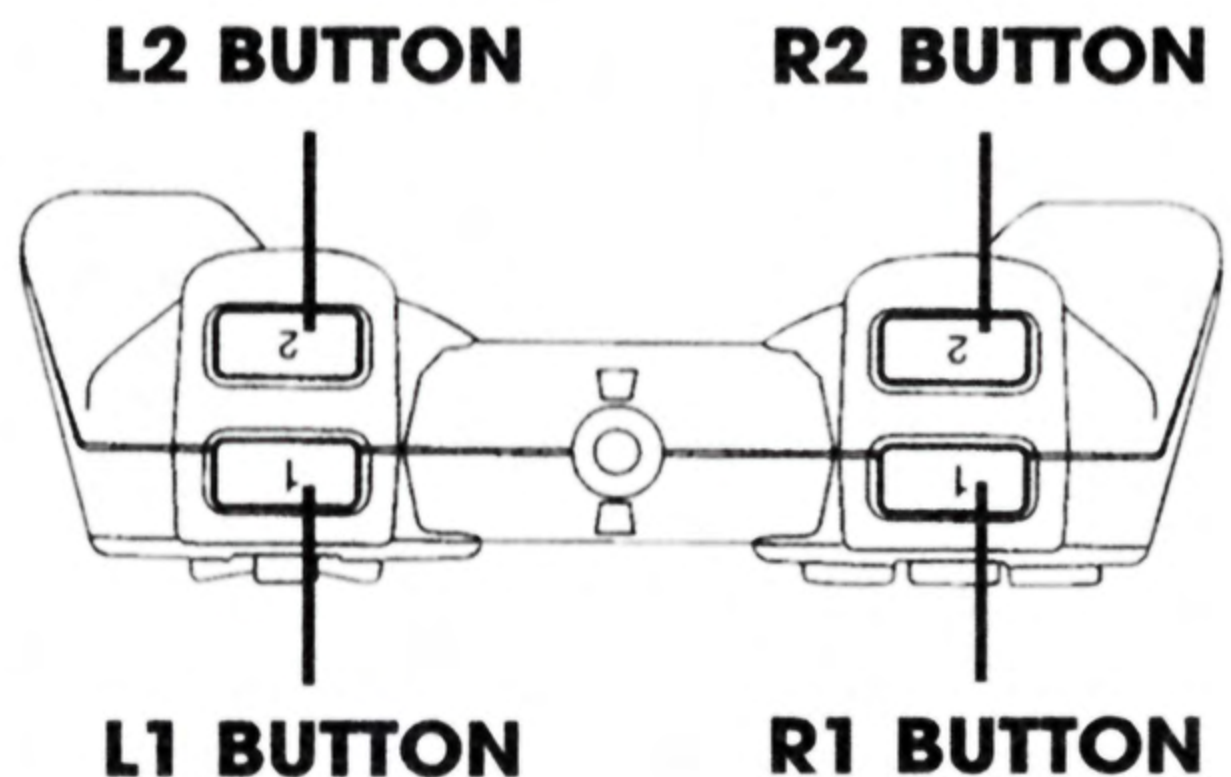

Note: Attitude is for up to 4 players. A Multi Tap (sold separately) is required for more than two players. To connect a Multi Tap, insert into Controller Port 1. Insert controllers into slots 1-4 on the Multi Tap. When using the Multi Tap, at least one controller must be connected to Controller port 1-A or 2-A.

Menu controls

- ↑ / ↓ _____ Highlight Menu Item
- ← / → _____ Toggle Highlighted Menu Settings
- ⊗ **BUTTON** _____ Confirm Selection/ Next Screen
- △ **BUTTON** _____ Cancel Selection/ Previous Screen
- START BUTTON** _____ Pause Game

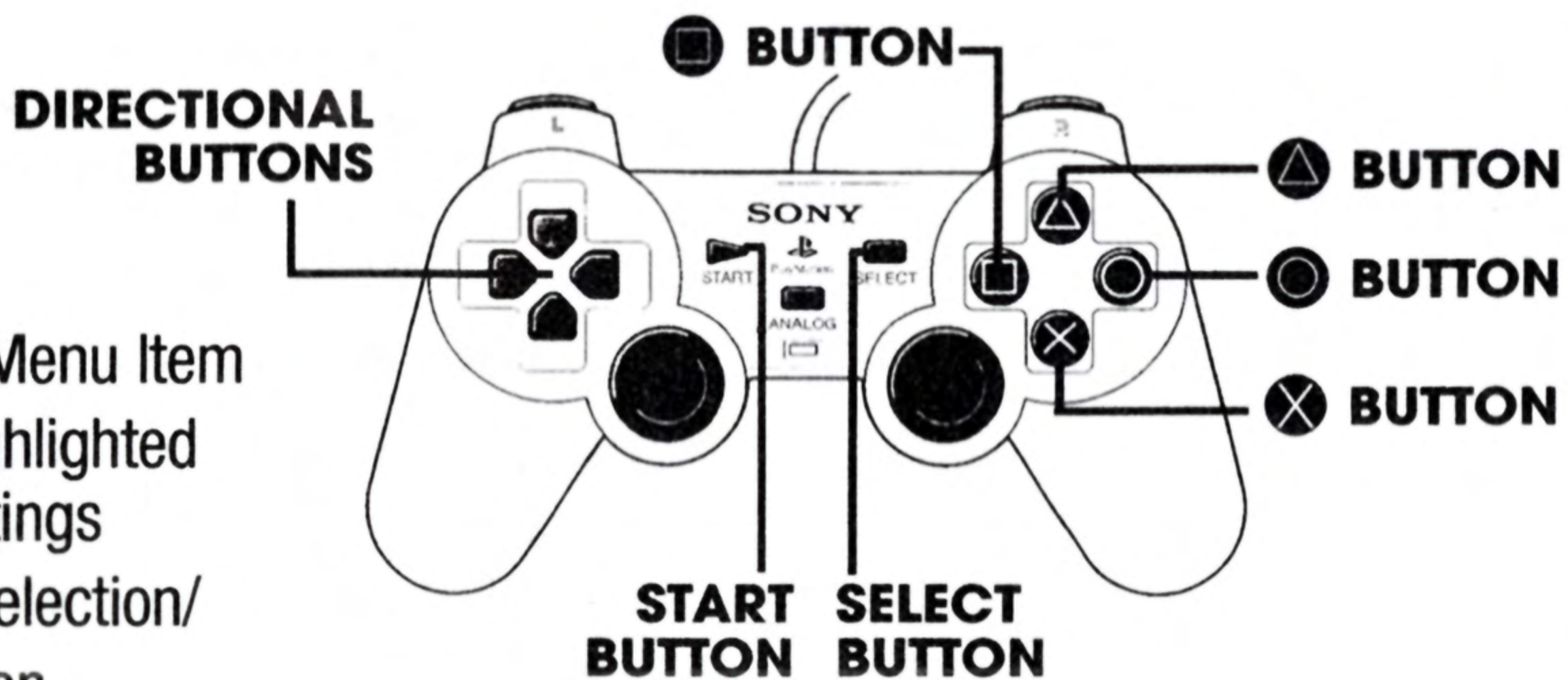

Do You Have ATTITUDE?

When it comes to competing against the elite athletes of the World Wrestling Federation®, you better have attitude! Because these mat maniacs don't back down from any challenge. They don't fear any fight, and **WF ATTITUDE™** has more ways to battle than you ever dreamed of! If you want to challenge the best, you better bring something extra to the ring. It takes more than knowing powerful special moves and humiliating finishing moves. It takes more than a willingness to take on the crushing blows of the long and wrenching Career climb, or mad melees like Gauntlet, King of The Ring® or Cage matches. You need a certain pride, a certain arrogance, a deep feeling in your guts that you're the best grappler in the ring. You gotta be rude, crude and in the mood to feud: You need Attitude!

A note about Gender: Throughout this booklet, small effort has been made to make the text "gender neutral". You know, littered with "his or her superstar" and the like. If you're among the many females who love wrestling, you may have the great sense and good grace to pardon these lapses and realize that deep down, it's not simply about men or women or even someone like Goldust—it's about the joy of great big people beating up on other great big people! Thanks, man.

It's Star time!

On the Title Screen, press the **START BUTTON**. You will go to the Main Menu. Here you can scroll to the desired mode and press the **X BUTTON** to select it.

Exhibition Try a variety of Exhibition matches!

Career Start here to begin your quest for wrestling's highest honors.

King of the Ring™ Get into the ring and battle up the ladder!

Pay-Per-View Create your own PPV wrestling spectacular!

Create A Wrestler Any match is livelier when you use a custom wrestler!

Utilities Manage your Memory card, Set Options and Controller Configurations.

WF ATTITUDE.
Get It!™

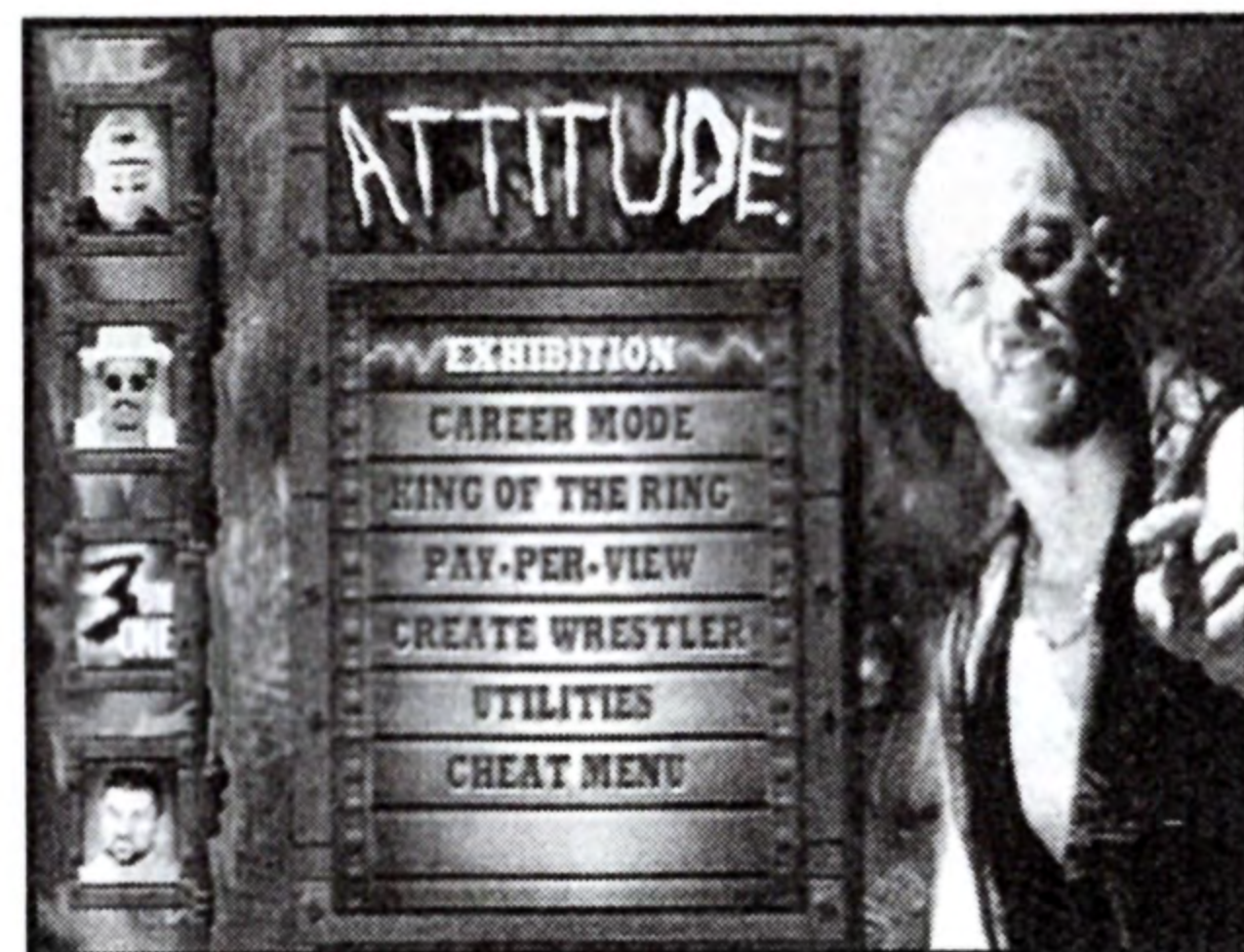

OPTIONS

Available options change depending on the type of mode and match you select. Below is a list of options. Utilities mode (see page 22) has additional options.

MATCH OPTIONS

Hardcore Match Make weapons available during your selected match.

Cage Match Turn the cage on during your selected match.

Last Man Standing Once an opponent gets knocked down, a counter will count to 10. If the number reaches 10 before the superstar can stand back up, he loses.

Falls Anywhere This allows players to be pinned outside ring.

Toughman Match This option is for the 2 on 1 and 3 on 1 game modes. If toughman is ON, the disadvantaged superstar must pin all of his opponents, not just one.

WIN MODIFIERS

Iron Man Match Turn winner of the selected match is the player with the most pins within a specific match length.

I Quit Match A player can only win by forcing the opponent to submit.

First Blood The winner is the first player to cause the other to bleed (if Blood option is turned on under Utilities).

Finisher Only The player can only win by using his finisher on the opponent.

2 out of 3 Victories The player must meet the win conditions 2 out of 3 times to win the match.

Time of the match This can be set from 2 minutes up to 20 minutes or no limit.

MORE OPTIONS

Simulation This allows you to watch the match as opposed to play the match.

Arena Allows the player to select the arena he/she wants to play in. The choices include: House, Raw, Pay-Per-View and Custom arenas.

Time Limit Limit can be set from 2 minutes up to 20 minutes, or no limit.

TKO If this is on, the match will end after a player has taken a specific amount of damage.

DEFAULT CONTROLS

RING BASICS

SELECTING PLAYERS AND MATCH TYPE

Once you select Career, Exhibition or Tournament mode, you will come to the selection screen.

NUMBER OF PLAYERS

Press  or  on the **DIRECTIONAL BUTTONS** to highlight the desired number of players.

Note that the match types available change with the number of human players.

MATCH TYPES

Press  or  on the **DIRECTIONAL BUTTONS** to scroll to the desired match type. Press the  **BUTTON** to select it.

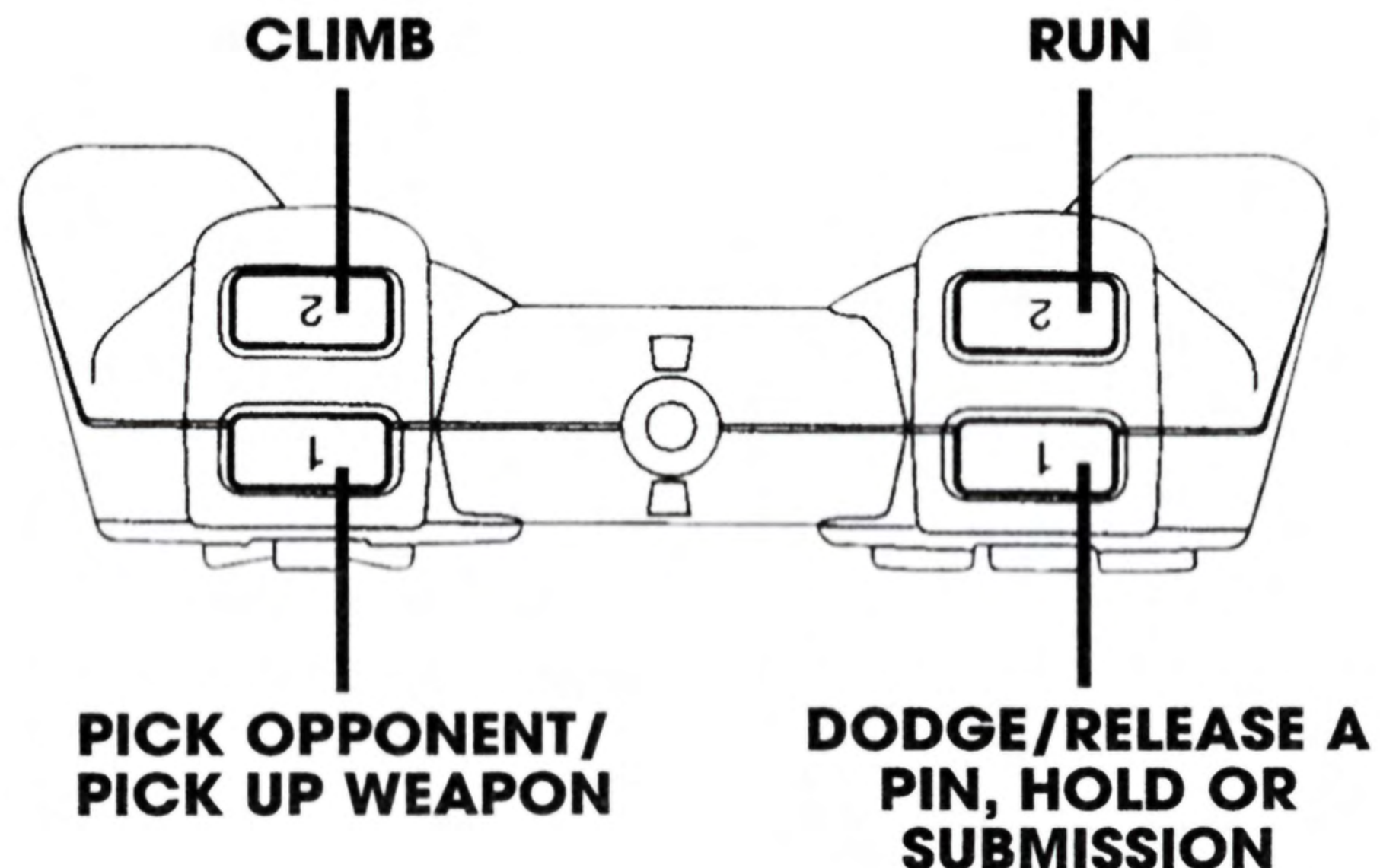
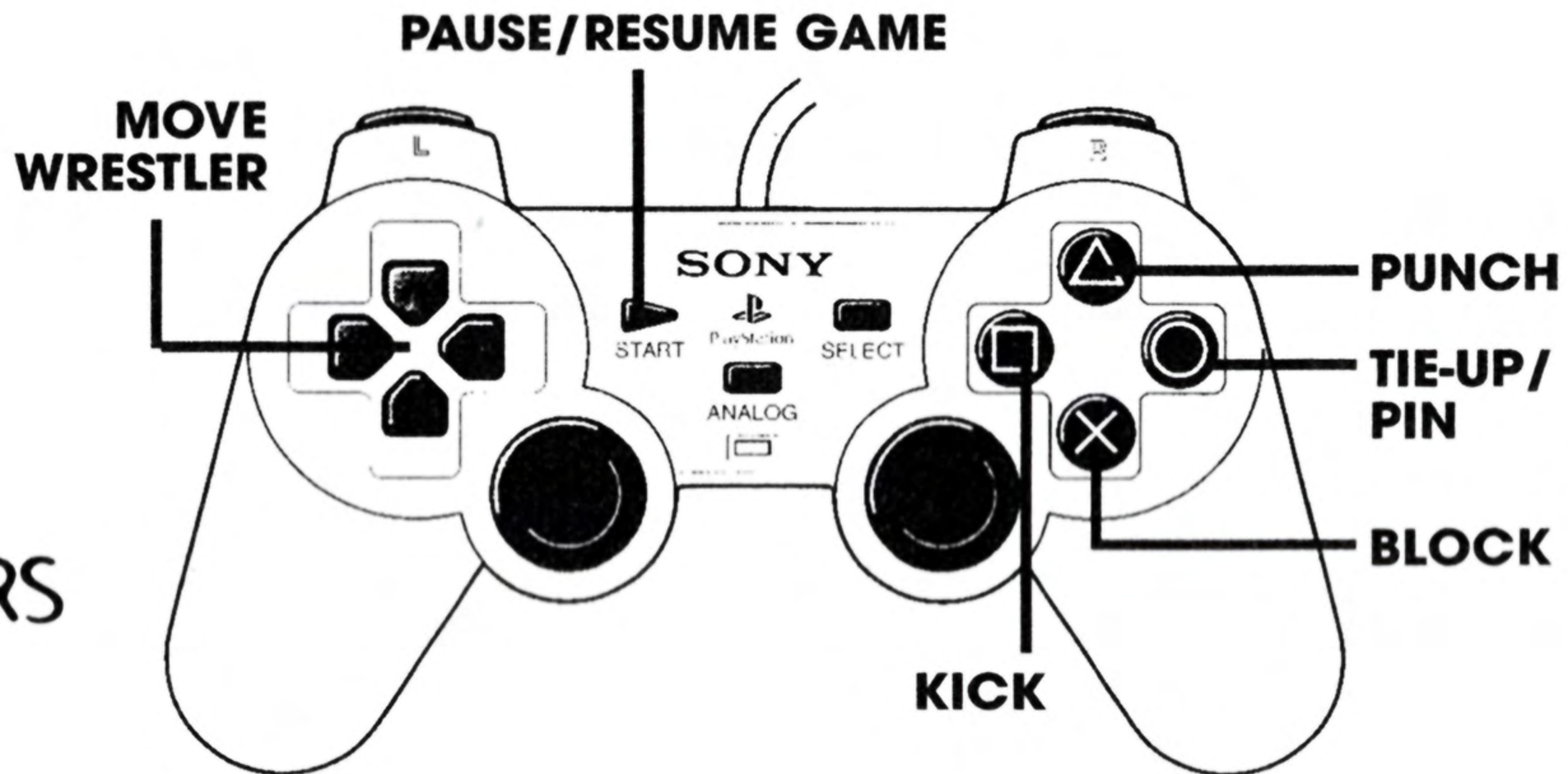

SELECTING SUPERSTARS

After selecting the number of players and the match type, select your superstars. Use the **DIRECTIONAL BUTTONS** to scroll to the desired superstar and press the **X BUTTON** to select, or press **R1** to have the CPU randomly select a superstar. Continue until you have chosen all the competitors needed for the selected match type. (Depending on the match type, you'll select the superstars you want to control, those the computer will control or have random ones assigned). Up to four players can select the same superstar, but be aware that the second selection will be considered an impostor. In Career mode, you select one superstar to guide through an entire season. In all other matches, Player 1 selects CPU* superstars.

***Note: In case you were wondering, CPU is geekspeak for Central Processing Unit, the main brains of a computer. In this manual, it means a computer-controlled superstar.**

CHOOSING CREATED WRESTLERS

If you've created and saved any wrestlers in Create A Wrestler (see page 19 for details), you can load them for use in any game mode. If you choose a Created Wrestler, you will go to the roster of saved wrestlers on your Memory Card where you can select which one you wish to bring into the ring. If no Memory Card is present or you haven't saved a created wrestler yet, you automatically get the default Created Wrestler.



THE SQUARED CIRCLE

POWER METER

Green You're in great shape—try anything!

Orange You're tired. You'll have to really start to mash the buttons to escape holds and submissions.

Red You're in danger—you can be pinned! Watch out for finishing moves!

TIE-UP METER As a superstar scores hits, the small box next to the superstar's name turns different shades of blue. The lighter the blue, the greater the advantage during a tie-up.

THE PAUSE SCREEN

Press the **START BUTTON** at any time during a game to bring up the Pause Menu. Press the **X BUTTON** to select a highlighted option, and to toggle settings for these options:

Resume Back into action!

Move List View a list of all your superstar's moves—and the controls!

Quit Return to the main menu.

GAME MODES

WF ATTITUDE™ offers an incredible array of wrestling modes. In fact, too many of them, if you ask me, which you didn't, but I'm writing this, not you, so I can say what I want, and I say there's just too many of them! You don't believe me? Just take a look!

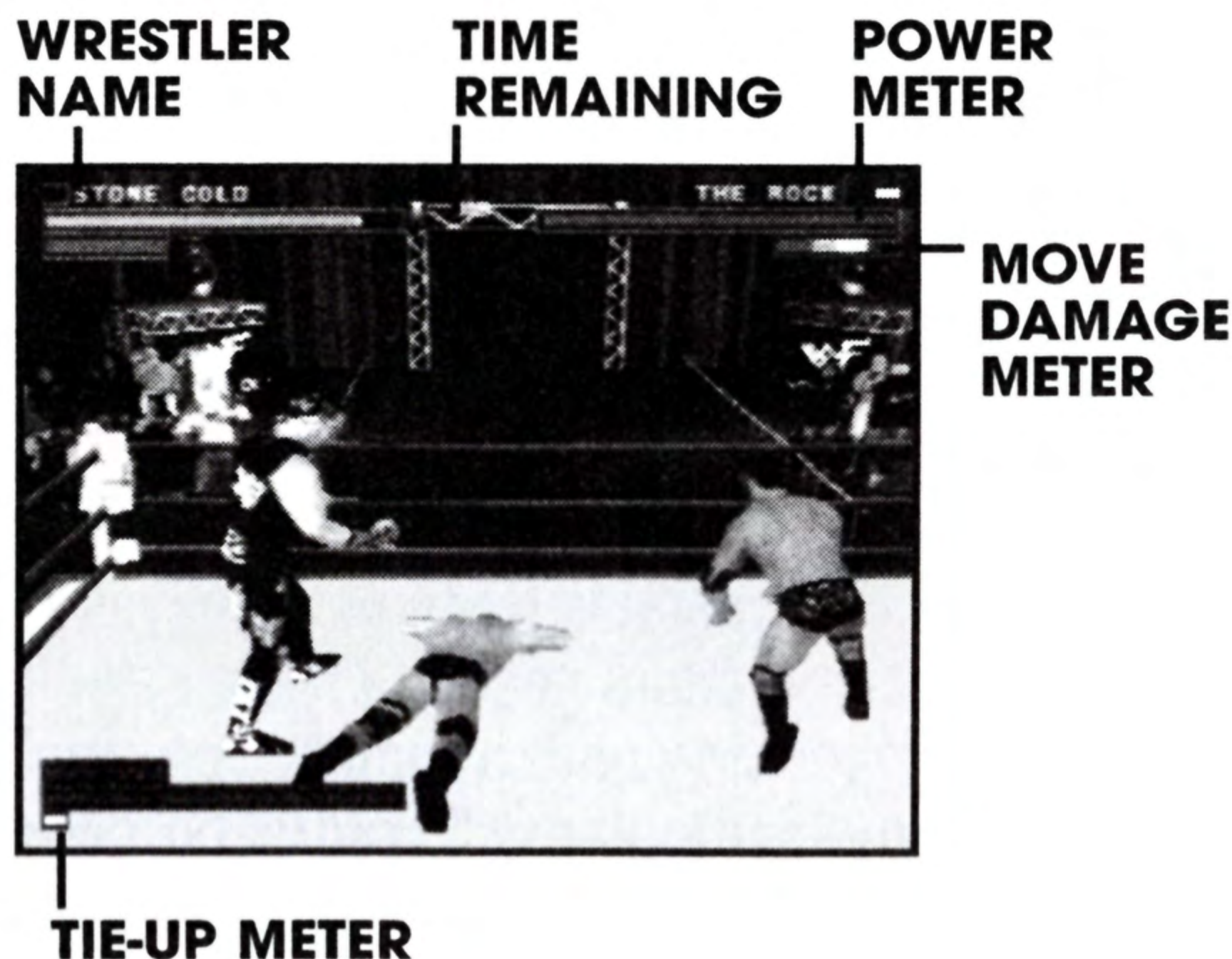

| 1 PLAYER | 2 PLAYER | 3 PLAYER | 4 PLAYER |
|------------------|-----------------------|-----------------------|----------------------------|
| CAREER | CAREER | CAREER | CAREER |
| TAG TEAM CAREER | TAG TEAM CAREER CO-OP | TAG TEAM CAREER CO-OP | TAG TEAM CAREER CO-OP |
| | TAG TEAM CAREER COMP | TAG TEAM CAREER COMP | TAG TEAM CAREER COMP |
| | | | TAG TEAM CAREER CO-OP/COMP |
| VS | VS | | |
| TAG TEAM | TAG TEAM | TAG TEAM | TAG TEAM |
| TORNADO | TORNADO | TORNADO | TORNADO |
| 1 ON 2 | 1 ON 2 | 2 ON 1 | |
| 1 ON 3 | 1 ON 3 | 3 ON 1 | 3 ON 1 |
| LUMBERJACK | LUMBERJACK | | |
| GAUNTLET | GAUNTLET | | |
| TAG GAUNTLET | TAG GAUNTLET | TAG GAUNTLET | TAG GAUNTLET |
| SURVIVOR SERIES™ | SURVIVOR SERIES™ | SURVIVOR SERIES™ | SURVIVOR SERIES™ |
| ROYAL RUMBLE™ | ROYAL RUMBLE™ | ROYAL RUMBLE™ | ROYAL RUMBLE™ |
| BATTLE ROYAL | BATTLE ROYAL | BATTLE ROYAL | BATTLE ROYAL |
| WAR | WAR | WAR | WAR |
| STABLE MATCH | STABLE MATCH | STABLE MATCH | STABLE MATCH |
| TRIPLE THREAT | TRIPLE THREAT | TRIPLE THREAT | |
| TRIANGLE | TRIANGLE | TRIANGLE | |
| | CO-OP TAG TEAM | | |
| | CO-OP TORNADO | | |
| | CO-OP 2 ON 1 | | |
| | CO-OP 3 ON 1 | CO-OP 3 ON 1 | |
| | CO-OP TAG GAUNTLET | | |
| | CO-OP SURVIVOR | | |

CAREER

This mode is for the real wrestling fan, the kind of player who's not satisfied with simply beating a few frenzied freaks and calling it a day. In this mode, you go through an entire  season, working up from a rookie in last place to winning the European Championship belt. After capturing that title, Career lets you continue to compete for the title in the Intercontinental division, and once that's earned, in the Heavyweight Championship division. By the time you've played through the Career, you're among the elite who can beat just about anybody! After you've beaten the CPU a few times, invite your friends over for a whipping, because this time around the Career can be played with up to 4 human players.

ABOUT CAREER MODE

You begin at the bottom, an untested rookie ranked 20th. You'll start off where all rookies start off: House shows. As you prove yourself and begin to move up in rank, you can start to show your stuff on Shotgun Saturday Nights. If you keep winning, pretty soon, you'll find yourself flirtin' with the fans and TV cameras on Sunday Night Heat™ and Monday Night Raw™. Ultimately, your skilled superstar will be eligible to compete in the coveted monthly Pay-Per-View matches, where you have a chance to prove yourself before the most devoted—and demanding—fans in the world. PPV matches include fan favorites like In Your House™, King of the Ring™, SummerSlam™, Survivor Series™, Royal Rumble™, and of course the ultimate PPV, Wrestlemania™! Once you're ranked #1, your next PPV match will be for an awesome honor: the European Championship Belt! If you win the belt, you'll keep your #1 ranking, and then have to defend your belt to prove you're not a paper champion. Five successful title defenses will do the trick. You will then enter into the bottom (#15 ranking) of the Intercontinental competition, where reaching a #1 ranking ensures you a chance at the Intercontinental Championship belt. Say you've earned the first two titles. Feeling pretty good, starting to believe you can beat anybody right? Well take a breather, brother, because you've got to start another round of competition if you want to prove you've got the complete package it takes to win the top belt: the Heavyweight Championship belt! Think you can take all three? Good luck! Better hit the Training Room hard and often, amigo!

FINE POINTS

House, Shotgun and Heat matches House shows are the beginning. Shotgun and Heat shows are televised but they don't include the same level of fanfare that a Raw or PPV would. These matches are worth 1 ranking point. They take place in smaller, less impressive surroundings. Hey, you gotta start somewhere, and for a beginner, that place is the bottom!

Raw is War™ This is the great televised Monday Night show you love. There is a random chance this match will be a specialty match. This type of match is worth 1 ranking point.

Pay-Per-View™ This is a special televised event. These matches have the most flash and include Superstar Intros. This type of match is worth 3 ranking points, so there's plenty on the line.

In Your House™ Compete against fellow superstars in a grueling specialty match.

King of the Ring™ This will be an 8 man tournament. This particular event doesn't end until the player has either lost 1 of the 3 matches or won all 3.

SummerSlam™ Random match types include: Weapons Match, Cage Match, Triangle Match, Triple Threat, Stable Match or various other matches.

Survivor Series™ Your regular superstar is teamed up with 3 other superstars to create a 4 man team to fight against an opposing 4 man team. If the player's team wins, his/her superstar moves up in rank, even if the player's superstar was pinned during the match.

Royal Rumble™ This is a 30 person, last-one-still-in-the-ring-wins match. Players who win this match are automatically catapulted to a rank of 1st, earning them the right to wrestle for the belt at the next PPV, depending on the situation.

WrestleMania™ This is a regular match. It is only played when a player is attempting to win the Heavyweight belt.

The Multiplayer Career

In a multiplayer version, there is an initial War match to place players in slots from 20th – 17th for 4 players (the winner is ranked 17th). After that, each player in rank order fights in a House match against a randomly selected CPU or human player. Losers are deducted 1 rank and winners are advanced 1 rank. Shotguns are used to break ties. If there are no ties, they are treated like House shows. Raw matches are always 4 player War matches and worth 1 point to the winner and –1 to the losers. When a player is ranked 1st he must fight in a war match versus the other human players to prove why he is the number 1 contender. If he wins, he will have the chance to take on the multiplayer career champion for the Heavyweight belt. If that #1 ranked player loses, the player's ranking is deducted by 3. All other superstars advance 1 rank.

TAG TEAM CAREER

The Tag Team Career is similar to the regular career mode, except all matches are tag matches, as your team battles to gain the Tag Team Championship belt. This match can be played with the players on the same team or on separate teams.

Exhibition Mode

Choose from a range of different matches and get ready for fast action!

VERSUS

This is the classic 1 on 1 match. Each player selects 1 superstar and they face off. The match continues until the rules set up by the player have been satisfied.

TAG TEAM

Tag team is a match that requires 4 superstars. Under regular rules this match would end as soon as a Legal superstar has been pinned. 2 superstars are outside of the ring standing on the apron kitty corner from each other. It is a 2 man team with only 1 man being able to stay in the ring legally. The illegal superstar has to stay outside on the apron until he is tagged. Once the legal man tags the illegal man, their positions switch.

The illegal man can enter the ring, but only for a count of 5 seconds. When the 5 seconds are up, the illegal man must then exit the ring and stay back in his team's corner. This time meter will

slowly fill back up to 5 seconds. However, the illegal man is free to come into the ring at any time as long as there is some in-ring time left on his meter.

To tag a teammate Walk over to the superstar and press **L1** to face your partner and then press the **TIE-UP/PIN BUTTON**.

2 ON 1

In this mode, 2 players face off against a single foe. The individual superstar must fend for himself while the other two superstars are free to pummel at will. The teamed superstars are free to attack the single superstar as much as they like and are not restricted to a tag format. Under normal circumstances, the match will end when a superstar from 1 team has pinned a superstar on the other team. The disadvantaged superstar doesn't need to pin both superstars.

3 ON 1

If 2 on 1 is too easy for you, try 3 on 1! The rules are the same, but the odds are much worse!

TORNADO

This mode features 4 superstars in the ring at once in a 2-on-2 match without tag team rules. The match ends when both people on one team have been eliminated. When 1 person is eliminated, the match becomes a 2-on-1 handicap match. The eliminated player can continue to wrestle outside of the ring on the floor, so beware!

LUMBERJACK

In this mode, 2 players face off in the ring. There is a catch, however. Outside the ring are 2 CPU controlled superstars eager to pound any poor, unsuspecting superstar who finds himself outside the ring.

Select your superstars, then choose 2 CPU lumberjack players who stay outside the ring on opposite sides. The rules for the match are a cross between a VS. match and a Royal Rumble™. You can still pin like a VS. match but you also have the extra throw-over-the-ropes moves available in the Royal Rumble. The CPU superstars outside the ring do not interact in any way with the superstars inside the ring—as long as the in-ring superstars remain inside the ring and are careful not to find themselves within grabbing distance of either CPU superstar outside the ring!

Once the superstars inside the ring wander outside it, they better have their affairs in order! The CPU superstars outside the ring are just waiting to pounce on anybody that gets thrown over the ropes or is stupid enough to walk outside the ring. Both CPU superstars outside the ring will focus on anyone outside the ring. If more than 1 superstar is outside the ring, the CPU superstars will each pick a different opponent. The CPUs will beat on their opponent until they have stunned them or the opponent gets back into the ring. Once the opponent is stunned, the CPU superstars will throw the opponent back into the ring. CPUs have unlimited health and are always on 100 difficulty—really fair, eh? Ouch! This style of match will keep any crybaby opponent or annoying friends from constantly running away from you, as any player that gets close enough to the ropes risks being pulled out and stomped by the lumberjack superstars! Timber!

GAUNTLET

In this mode, 2 players face off in the ring, but one opponent has a big advantage: one player is able to select a 4 man team! The player with a 1 man team must defeat all members of the other team. In a 1 player gauntlet, the user fights a CPU one-on-one until the CPU is eliminated. Once the user has eliminated his opponent, another superstar appears that the user must fight. This continues until the user has successfully beaten 4 CPU opponents!

TAG TEAM GAUNTLET

This mode is similar to a regular gauntlet mode, but with a teammate. In this mode, the player and his/her teammate fight a teamed-opponent. As the enemy superstars are eliminated they are replaced with fresh teammates until all superstars on the enemy team have been eliminated. If both the player and his/her teammate are defeated before they defeat the enemy superstars, the match is over. Tag Team rules apply.

SURVIVOR SERIES™

Only the STRONG survive! This mode is a Tag Team marathon match with 2 teams. Each team has 4 superstars and it's a fight to the finish. However, each team has his/her tag partner and 2 other teammates waiting in the wings. Whenever superstars are eliminated, they are replaced with the tag partner on the apron and a teammate waiting in the wings comes in to become the new tag partner. The match ends when there is only 1 team left.

ROYAL RUMBLE™

The Royal Rumble is among the wildest spectacles in wrestling, a straight ahead free-for-all with no pins, no submissions, and no count outs! You can't even leave the ring and fight outside! It begins with 2 superstars grappling in the ring. Another superstar enters every 30 seconds. This continues until 4 superstars are in the ring at once. You eliminate opponents by throwing them over the top rope. Once a superstar is eliminated, another fills that spot, until all 30 superstars have been in the ring! When the Rumble is over, a stat screen will appear showing how many times you eliminated someone, how many times you were eliminated, and how much in-ring time you had. The winner is the last man in the ring. The Royal Rumble also lets you select superstars for all 30 superstar slots if you want.

BATTLE ROYAL

The rules for Battle Royal are exactly the same as the rules for Royal Rumble with the following exceptions: all 4 players start in the ring at the same time and there are only 4 superstars. The match ends when there is only 1 superstar left in the ring.

WAR

There are 4 superstars in the ring at once in a free-for-all style. The match ends when there is only 1 superstar left. Once a superstar has been eliminated, he/she is forced outside of the ring, but can still pull people out and beat anyone outside of the ring.

STABLE MATCH

Like a War match, but each player has a team of 4 superstars. When a player gets pinned, his/her superstar leaves and a new one comes out until all his/her superstars are eliminated. The match ends when there is only 1 superstar left in the ring and all of the other team's superstars have been eliminated. Also, the last member of each team is allowed to remain outside the ring and fight with any other superstars outside the ring or superstars that he/she drags from inside the ring to outside the ring.

TRIANGLE

This type of match is very similar to a Vs. match. Three people are in the ring at once in a free-for-all-format. The match ends after 2 superstars have been eliminated. The winner is the superstar that didn't get eliminated.

TRIPLE THREAT

This match is similar to a Triangle match. The difference is that once a person has been eliminated, the match is over and the victory goes to the person who pinned or submitted the eliminated person. This type of match prevents double teaming.

SOME SPECIALTY MATCH TYPES

In **WRESTLING ATTITUDE™**, you'll come across some truly brutal match types, which can show up at any time. Here's a taste of what to expect, besides a lot of yelling and whimpering.

STEEL CAGE MATCH

The winner is the first superstar to climb out of the cage, usually leaving a helplessly beaten opponent lying on the mat below. If you think you can climb out to safety before your opponent is down, you'll soon have that faith shaken, friend, along with every bone in your body! The player can turn the Steel Cage on in Options before starting a match.

WEAPONS MATCH

In a Weapons match, the rule book is just something to stand on to get a better view of the action! Just about any object can be used to punish your opponent. Your opponent will be thinking warmly of you, too, so be prepared to take on anything—including the kitchen sink! The player can turn weapons on in Options before starting a match.

King of the Ring™

In this mode, the superstars face off in regular Vs. matches in a playoff-style tournament. If a player wins, he/she advances to the next tier. The mode is complete when there is only 1 superstar left. On the Options screen before each match the players can choose to watch the match or simulate a winner. Simulating a match will return the player to the tournament screen, with the winner advancing. Up to 8 human players can compete in King of the Ring tournaments. Player 1 will select all of the superstars. All players will wrestle using Controllers 1 and 2.

Pay-Per-View

Want to relive some of the greatest wrestling matches ever broadcast? Ever wanted to create the perfect wrestling ticket? “Create your Own Pay-Per-View” mode is for you! In this mode you get to build a Pay-Per-View from the ground up. You can pick the name of the event, select the colors of the apron curtains—even choose between a House arena and a Pay-Per-View arena! You can also pick the type of matches for the Pay-Per-View, select the superstars who will participate in the Pay-Per-View and determine which superstars face which superstars—you’re the big shot now!

NOTE: Pay-Per-View requires a Memory Card. A PPV event cannot have more than one Stable and one Royal Rumble.

PAY-PER-VIEW SETUP

When you select Pay-Per-View, you’ll come to the Pay-Per-View Setup screen.

NAME EVENT:

Use your controller to give your Pay-Per-View a name. This name will appear on the apron. How about “Ring Toss”?

- **DIRECTIONAL BUTTONS** to select a character.
- Press the **X** **BUTTON** to enter the character.
- Select **END** and press the **X** **BUTTON** when the name is complete.
- Press the **Y** **BUTTON** to return to the PPV setup menu.

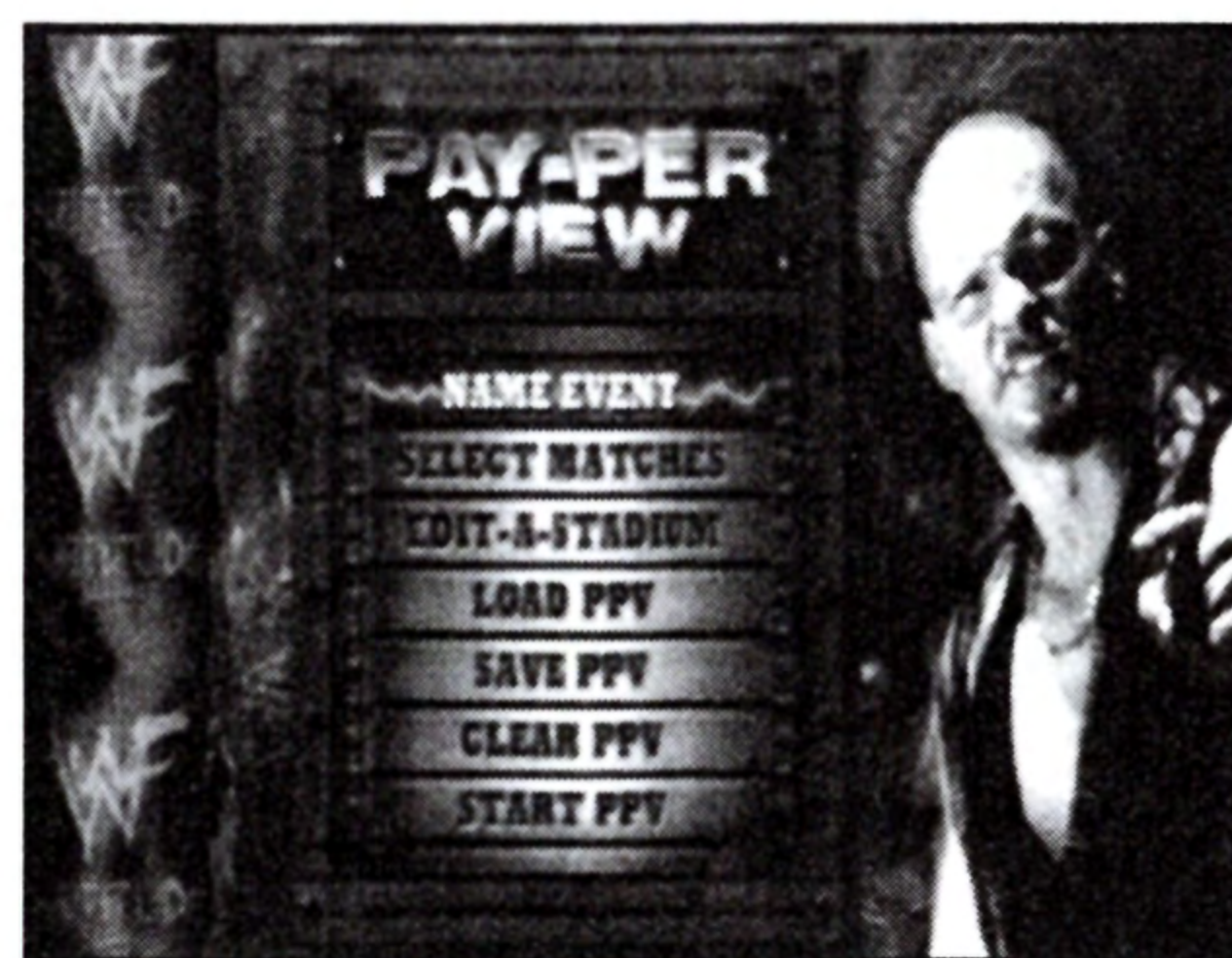

Select Matches There are 8 match slots available. You can use as many or as few of the slots as you like. When a slot is selected, a pop up menu lets you choose Exhibition or Tournament style play. At the next screen, select how many players will compete, then scroll to the desired match and press the **X** **BUTTON**. Once you select a match type you'll go to the superstar select screen to choose the superstars for that particular match. Press the **△** **BUTTON** to cancel a selection and go back to a previous screen.

EDIT A STADIUM

Customize the look of your PPV spectacular!

Stadium Select where you want the action to take place.

Ring Lights Bathe your event in beautiful lights!

Entrance Color Select the color of the stage entrance area.

Ring Apron Select from several different banners to hang on the ring apron.

Side Curtains Change the color of the curtains surrounding the ring.

Pad Color Select from a palette of 9 colors. Martha Stewart, eat your heart out!

Post Color Select the color of the corner posts.

Rope Color Hey, that matches my tights!

Stage Signs Select different banners to hang on the stage.

Entrance Sign Select different banners to hang inside the entry way.

Scaffold Banner Select different banners to hang on the scaffolding.

When you've set up the stadium to perfection, press the **△** **BUTTON** to return to the Pay-Per-View Setup screen.

When you're ready, select **START PPV** to bring up the PPV Summary screen showing the PPV name, and a list of all the events scheduled. You will return to this screen when each of the match types has been completed. The winners of each event are displayed, along with some statistics: Winner Name, Winner Picture, Player #/CPU or Human, etc.

Load PPV Load up and play a previously saved PPV.

Save PPV Save your current PPV progress and settings.

Clear PPV Reset the Pay-Per-View.

Start PPV Begin your ~~WF~~ SuperStar spectacular!

Create A Wrestler

“Create A Wrestler” is back and it’s bigger, bolder and outright goofier than ever! New boots and panties indeed! This is where you can create, edit and save custom superstars. Then you can take them in to the ring to prove their mettle in the midst of all manner of ~~WF~~ **ATTITUDE**™ mania!

CONTROLS

○ BUTTON Select brightness meter.

↑ or ↓ DIRECTIONAL BUTTONS Highlight Option.

← or → RIGHT DIRECTIONAL BUTTONS Cycle settings/move sliders.

R1 + L1 Turn wrestler in view window.

CREATING YOUR WRESTLER

Create Access the create menu, where you can alter all sorts of custom creature settings, including which style eyes, nose, body type and wiggy costume combo your mighty mangler will sport!

Name Give your perfect creature the perfect name.

Attributes Assign the desired mix of attributes like stamina, speed, etc.

Edit Moves Choose which moves your wrestler can pull off.

Personality No neurosis here, just Attitude! Use this screen to select your theme music, run-in partner and whether the crowd cheers or boos your wrestler.

Memory Card Access your Memory Card to use Save and Load functions.

Reset Erase the current creation.



Highlight **Create** and press the **X** **BUTTON**. A menu will appear with a number of options: Body, Head, Upper, Lower, Text, Random and Clear. Select random to have the computer create a wrestler with random elements. Clear will clear any unsaved current creations. The remaining options each have several sub-categories of unwholesome options you can set. Get in there and see what you can do! Press the **X** **BUTTON** when an option is highlighted. A sub-menu will appear with all the settings you can handle. Scroll up or down to highlight an option, then press the **X** **BUTTON** to enter.

COLOR SETTINGS

You can set the color/tone on some selected items. To do so, press the **C** **BUTTON** to activate the color area, press **↑** or **↓** on the **DIRECTIONAL BUTTON** to highlight a color option slider, then move the slider (**←** or **→**) to get the look you want. When you're done, press the **△** **BUTTON** to return to the menu area.

Different options have different color adjustment options available. You can usually adjust:

Hue All the colors of the rainbow, from yellowed bruise to black-eye blue!

Saturation Sets the amount of color.

Brightness Make the color dark or light.

LENGTH SETTINGS

From Upper Shirt and/or Lower Pants, you will be able to adjust sleeve and pant lengths to get that all-important $\frac{3}{4}$ length look that's so IT this year. To access the length meter, press the **C** **BUTTON** twice (the first press highlights the color settings), then press **←** or **→** on the **DIRECTIONAL BUTTON** to raise or lower your hems! Ooohhh!

ADDING TEXT TO CLOTHES

When Text is highlighted on the **CREATE MENU**, press the **X** **BUTTON** to bring up the text editing screen. Select an area you wish text to appear on and press the **X** **BUTTON**. You'll come to the text input screen. Press the **X** **BUTTON** on a selected line to access the text input window, then use the **DIRECTIONAL BUTTONS** to highlight desired characters and the **X** **BUTTON** to input a character. When text is complete, highlight **NEXT LINE** and press the **X** **BUTTON**.

Text options You can choose a large or small font and vertical or horizontal text alignment under Options. Press the **○ BUTTON** to access the options area, then use the **DIRECTIONAL BUTTONS** to highlight your choice. Press the **⊗ BUTTON** to confirm. You can set text color by moving the slider. Press the **△ BUTTON** to return to the body area menu. You can also change the text color and which layer of clothing the text appears on.

Attributes

You assign your creation varying degrees of five attributes (from 1 to 10), with the total equal to 36. Common sense suggests you create a superstar with balanced attributes, heavier in some areas, lighter in others, but have fun experimenting by creating creatures with, say, plenty of strength but no endurance, or lots of recovery but no speed. You're sure to find their resulting performance entertaining! The attributes are:

Strength Affects damage you deliver.

Toughness Makes you less vulnerable to low-damage attacks like punches and kicks.

Speed Impacts walks, blocks, dodges, climbing the Turnbuckle and Cage.

Recovery Initial recovery value is lower, plus it lowers your chance of getting stunned.

Charisma Increases the chances of getting the crowd on your side. A happy crowd pumps you up so you do more damage.

Mat Skills Improve your ability to reverse moves and do more damage during holds.



MOVES

You can choose which moves you want your custom superstar to have for particular situations, and there are plenty to choose from! To edit a move set, move the highlight to Finisher, Trademark or one of many, many Damage moves (arranged by the level of damage they do). Press the **X** **BUTTON** to highlight the moves

window at the lower left of the screen. Press **←** or **→** **DIRECTIONAL BUTTONS** to toggle through the different situations, and **↑** or **↓** to scroll the moves available for

each situation. Notice that button combinations for each move appear in the window at the lower right. When you've selected your move for one category (say, your Finisher), press the **△** **BUTTON** to get back to the move set selection menu and continue until you've got an arsenal of moves that will make your opponent cry "Uncle!"

Names Enter your own, or choose a selectable Name – You can select from a heaping helping of ring-tested names. When a player uses this superstar in the game, the announcers will refer to the superstar by the name he selected in the custom room.

Utilities

Utilities offers a host of gaming options, plus a separate Controller Configuration screen. The main utilities screen offers you these choices:

Control Config See next page for details.

Save Options Access your Memory Card to save option settings.

Difficulty Select among Easy, Medium and Hard skill settings.

Intros Choose to play with or without the  SuperStar intros.

Recovery Superstars will regain health during a match (ON) or not (OFF).

Stereo Play with Stereo or Mono sound.

FX Volume Turn sound effects OFF, or choose among Low, Medium and High settings.

Music Volume Turn the music OFF, or choose among Low, Medium and High settings.

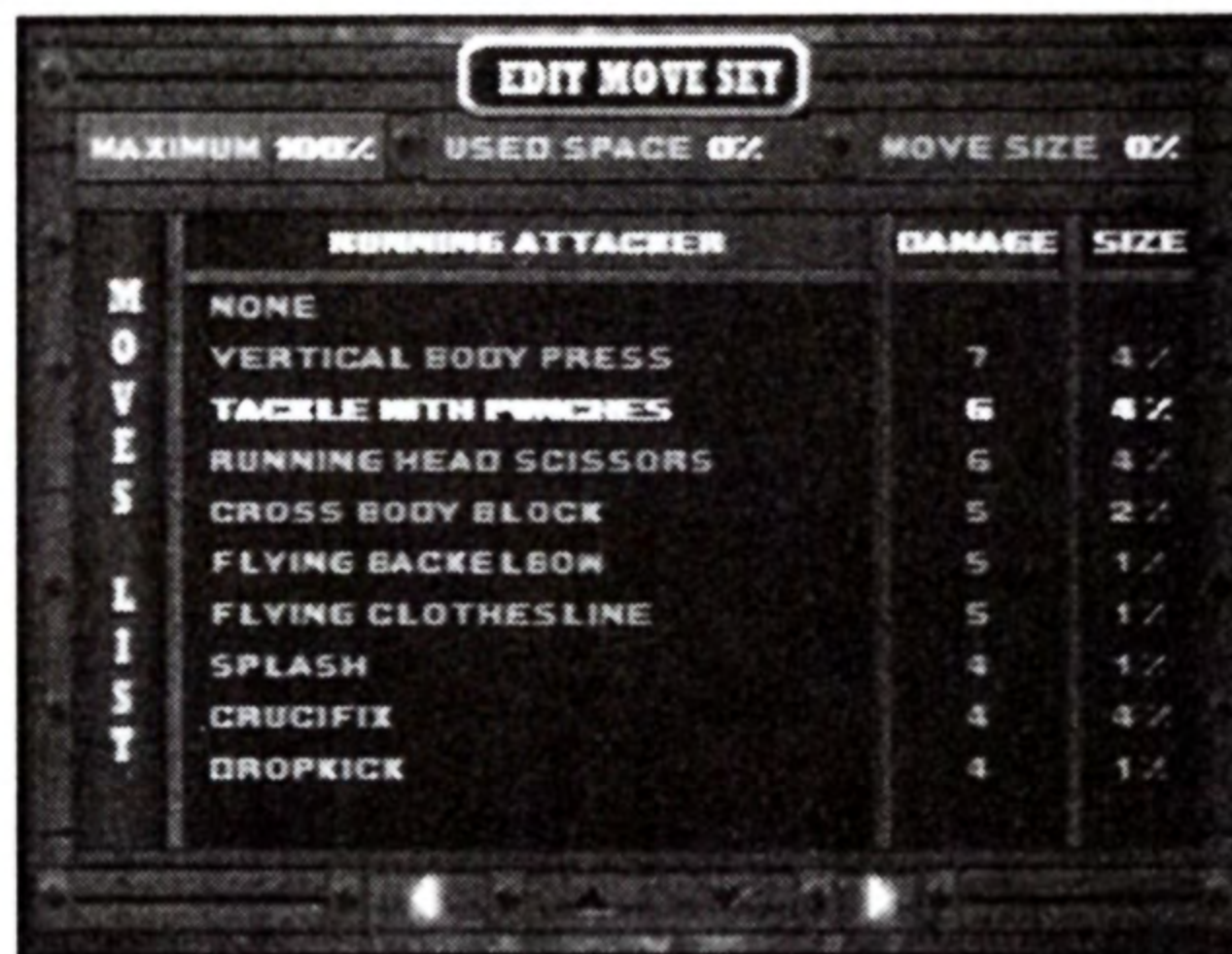

Blood Play with festive blood (ON) or don't (OFF).

Language Choose ON or OFF. When ON, the censor hides some of the game's **ATTITUDE**.

Name Meter Select among ON, OFF and HEALTH COLOR. I for one don't get it.

Damage Meter Turn this meter ON or OFF.

Tie-Up Meter Turn this meter ON or OFF.

Health Meter Turn this meter ON or OFF.

CONTROLLER CONFIGURATION

Take a look at the default settings, or change them to suit your style. All of the players can change their configuration at the same time. Player 1 has control over entering and exiting the screen. Each player just needs to highlight a control and then press the button he/she wants to use to do that action. When each player is done, he/she presses the Done button and presto!—the changes are saved.



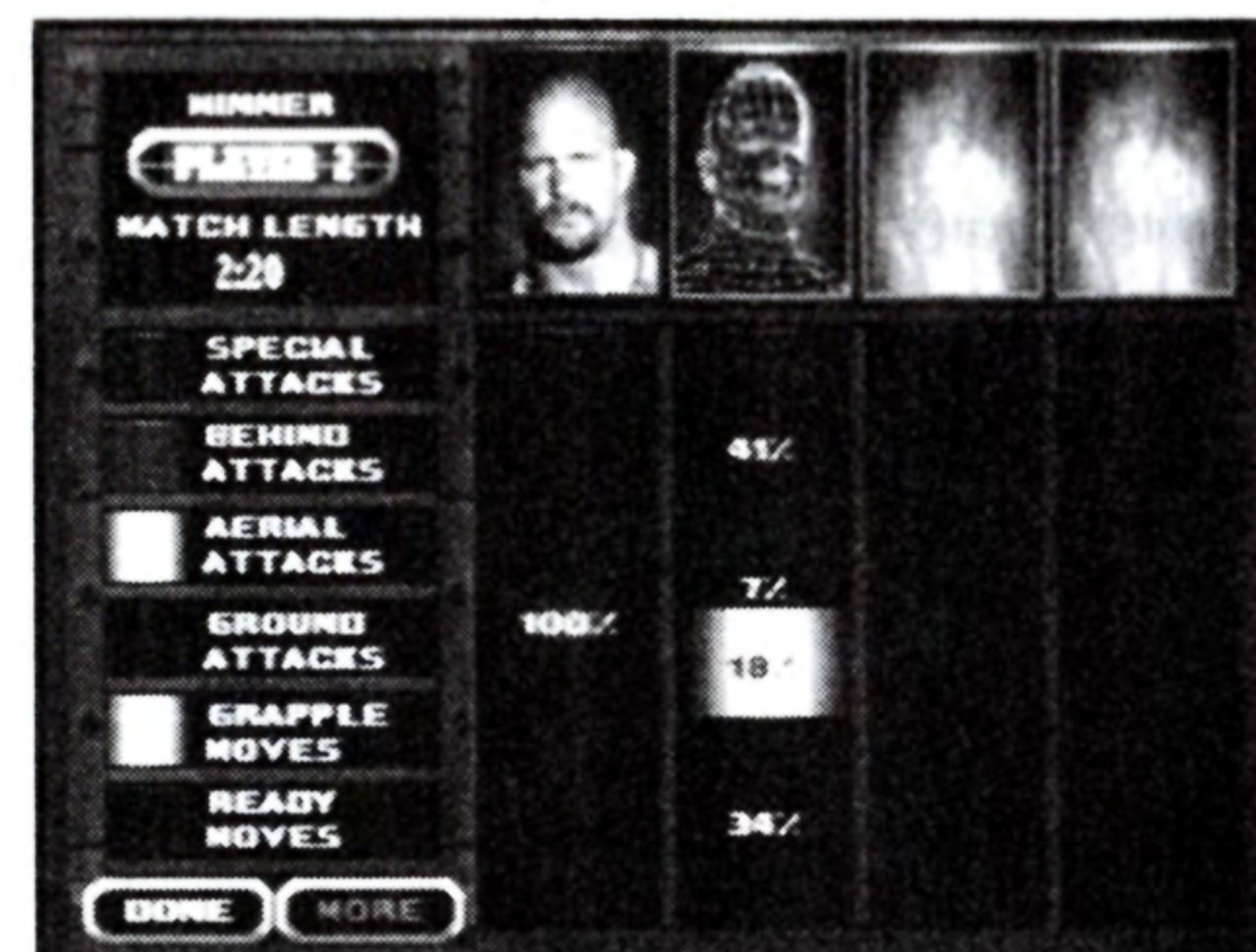

MATCH STATISTICS

At the end of each match the game will compile statistics about the match that was just fought, including the winner, match length, a moves chart that tells how much you're using specific moves from each category. A second screen details pin attempts, total damage and plenty more!



Superstar Biographies

The talent in the  is staggering. Here are the mighty men and women that make  the most complete and compelling wrestling game ever. If you're good enough to master the mat using this huge roster, you may find some special secret wrestlers, too! How well do you know these top talents? Can you match the wrestler to his or her portrait?

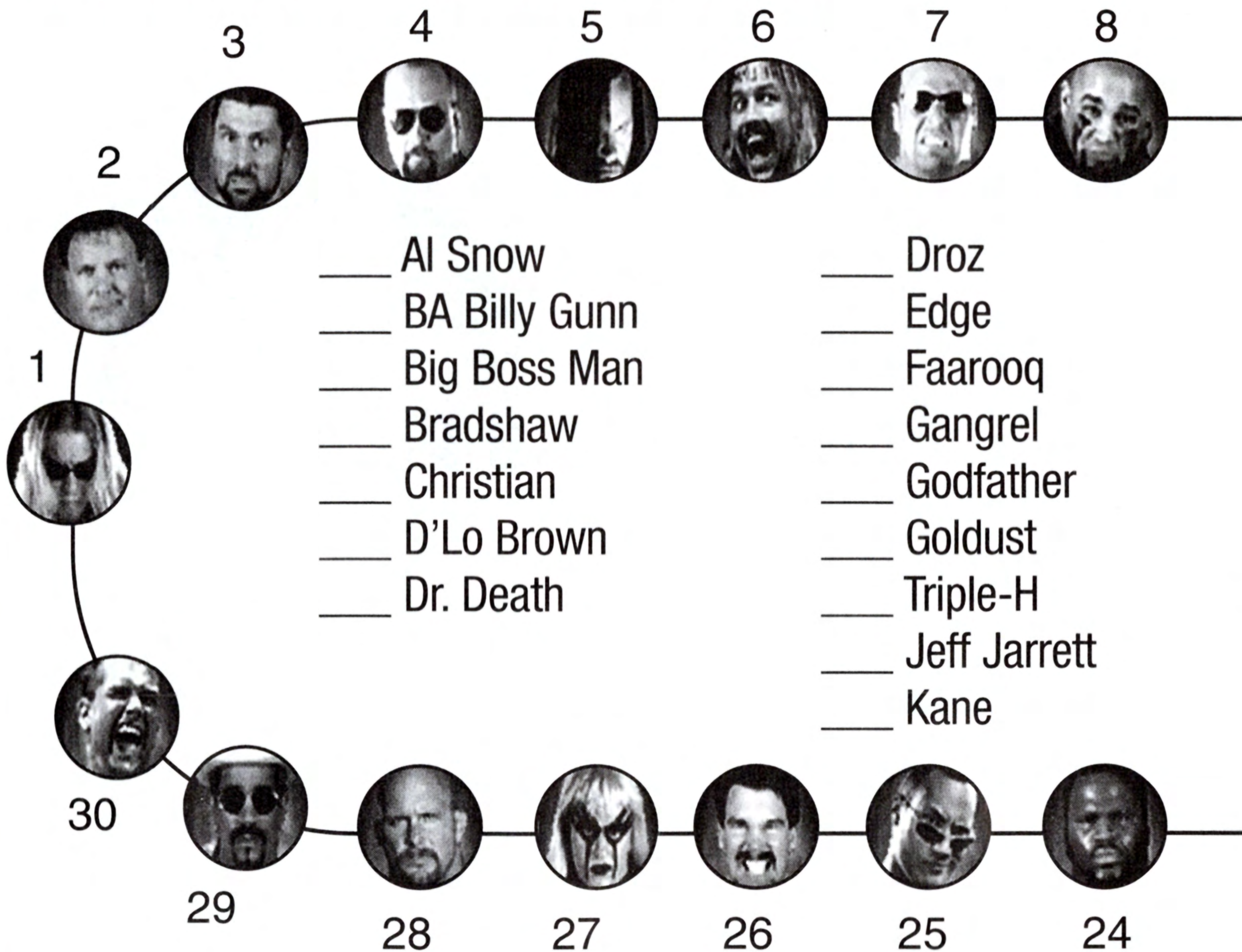

30

29

28

27

26

25

24

3

4

5

6

7

8

2

1

___ Al Snow

___ BA Billy Gunn

___ Big Boss Man

___ Bradshaw

___ Christian

___ D'Lo Brown

___ Dr. Death

___ Droz

___ Edge

___ Faarooq

___ Gangrel

___ Godfather

___ Goldust

___ Triple-H

___ Jeff Jarrett

___ Kane

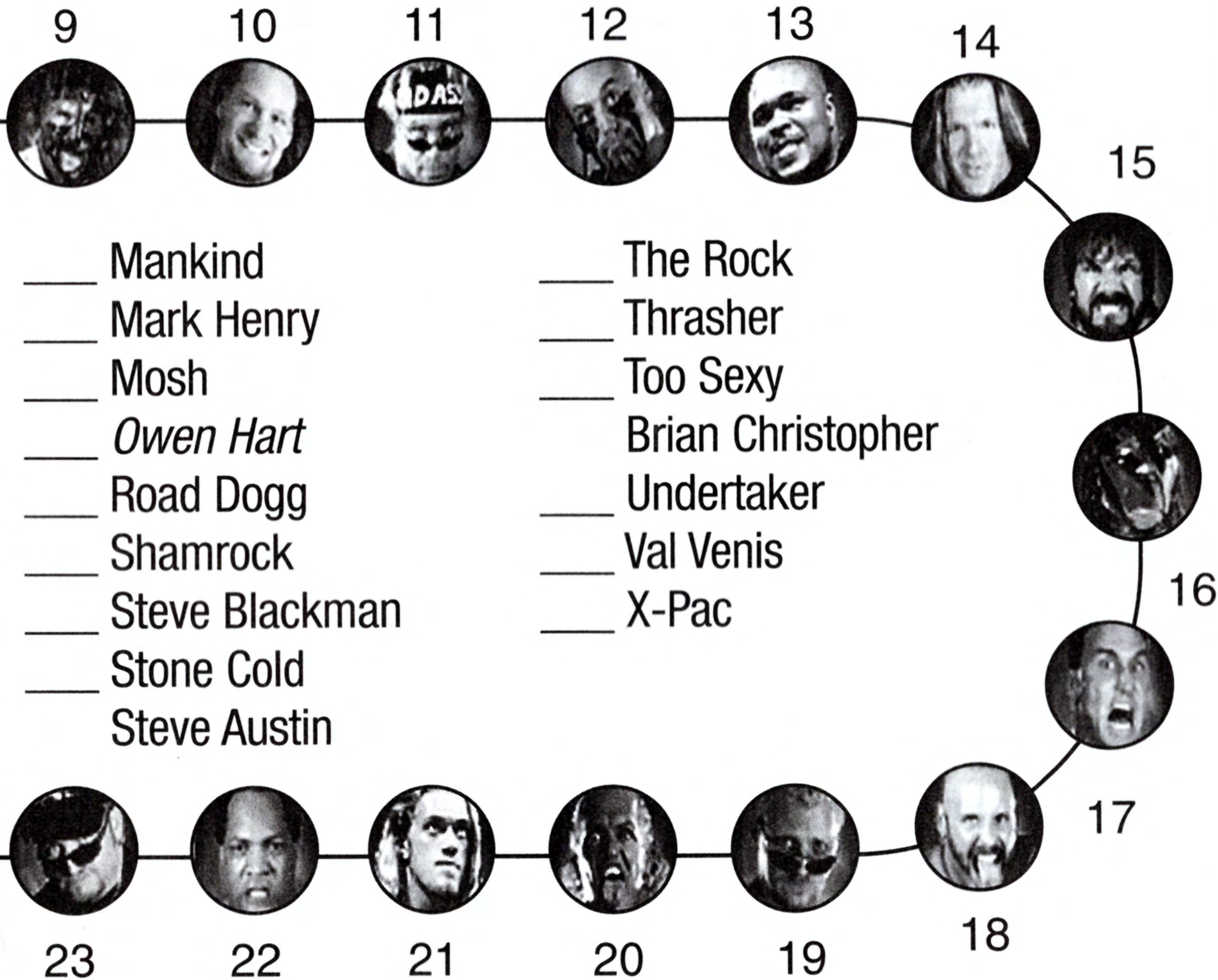

OFFICIAL ACCLAIM STRATEGY GUIDE

GUIDES CAN BE
ORDERED THROUGH
OUR WEBSITE

www.acclaimsports.com

or by calling

(716) 461-4839,
9AM-7PM EST
Monday through
Friday

ATTITUDE

Get It!

Acclaim
SPORTS™



ACCLAIM® LIMITED WARRANTY

ACCLAIM warrants to the original purchaser only of this ACCLAIM software product that the medium on which this software program is recorded is free from defects in materials and workmanship for a period of ninety (90) days from the date of purchase. This ACCLAIM software program is sold "as is," without express or implied warranty of any kind, and ACCLAIM is not liable for any losses or damages of any kind resulting from use of this program. ACCLAIM agrees for a period of ninety (90) days to either repair or replace, at its option, free of charge, any ACCLAIM software product, postage paid, with proof of date of purchase, at its Factory Service Center. Replacement of the software product, free of charge to the original purchaser (except for the cost of returning the software product) is the full extent of our liability.

This warranty is not applicable to normal wear and tear. This warranty shall not be applicable and shall be void if the defect in the ACCLAIM software product has arisen through abuse, unreasonable use, mistreatment or neglect. THIS WARRANTY IS IN LIEU OF ALL OTHER WARRANTIES AND NO OTHER REPRESENTATIONS OR CLAIMS OF ANY NATURE SHALL BE BINDING ON OR OBLIGATE ACCLAIM. ANY IMPLIED WARRANTIES APPLICABLE TO THIS SOFTWARE PRODUCT, INCLUDING WARRANTIES OF MERCHANTABILITY AND FITNESS FOR A PARTICULAR PURPOSE, ARE LIMITED TO THE NINETY (90) DAY PERIOD DESCRIBED ABOVE. IN NO EVENT WILL ACCLAIM BE LIABLE FOR ANY SPECIAL, INCIDENTAL, OR CONSEQUENTIAL DAMAGES RESULTING FROM POSSESSION, USE OR MALFUNCTION OF THIS ACCLAIM SOFTWARE PRODUCT.

Some states do not allow limitations as to how long an implied warranty lasts and/or exclusions or limitations of incidental or consequential damages so the above limitations and/or exclusions of liability may not apply to you. This warranty gives you specific rights, and you may also have other rights which vary from state to state.

This warranty shall not be applicable to the extent that any provision of this warranty is prohibited by any federal, state or municipal law which cannot be pre-empted.

Repairs/Service after Expiration of Warranty—If your software product requires repair after expiration of the 90-day Limited Warranty Period, you may contact the Consumer Service Department at the number listed below. You will be advised of the estimated cost of repair and the shipping instructions.

Acclaim Hotline/Consumer Service Department (516) 759-7800

 Attitude, World Wrestling Federation® and its logos are trademarks of Titan Sports, Inc. © 1999 Titan Sports, Inc. All Rights Reserved. Acclaim® © 1999 Acclaim Entertainment, Inc. All Rights Reserved. Developed by Acclaim Studios Salt Lake City. All Rights Reserved. Jeremy McGrath SUPERCROSS™ 2000 and Acclaim® © 1999 Acclaim Entertainment, Inc. All Rights Reserved. Developed by Acclaim Studios Salt Lake City. All Rights Reserved. Marketed by Acclaim. Distributed by Acclaim Distribution, Inc., One Acclaim Plaza, Glen Cove, NY 11542-2777.

www.acclaimsports.com

JEREMY MCGRATH SUPERCROSS 2000™



Acclaim®
SPORTS



www.acclainsports.com

Licensed by Sony Computer Entertainment America for use with the PlayStation game console. PlayStation and the PlayStation logos are registered trademarks of Sony Computer Entertainment Inc. The ratings icon is a trademark of the Interactive Digital Software Association. Manufactured and printed in the U.S.A. THIS SOFTWARE IS COMPATIBLE WITH PLAYSTATION GAME CONSOLES WITH THE NTSC U/C DESIGNATION. U.S. AND FOREIGN PATENTS PENDING.

